

SI-7AB0A

SERVICE INSTRUCTIONS

INSTRUCTIONS DE MONTAGE

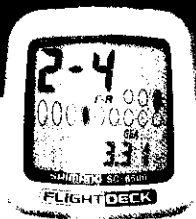

Cycle Computer **SC-6500**

**FLIGHTDECK**

**SHIMANO™**

# Cycle Computer

## SC-6500

### INDEX

<b>1. External appearance</b> .....	<b>5</b>
<b>2. Display Contents</b> .....	<b>6</b>
<b>3. Display Modes</b> .....	<b>8</b>
• Current speed (VEL) .....	<b>9</b>
• Gear indicator (bar) • Time display (CLK)	
• Trip distance group (TIM, DST, MAX, AVE) ...	<b>10</b>
• ODO meter (ODO) .....	<b>11</b>
• Stopwatch (STW) group	
• Cadence (rpm) .....	<b>12</b>
• Main display cadence (VEL) • Lap counter (CNT)	
• Digital gear number F-R .....	<b>13</b>
• Gear ratio • Pace Arrow	
• Low battery display (LO BAT)	
• Power saver function .....	<b>14</b>
<b>4. Resetting</b> .....	<b>14</b>
<b>5. Viewing data after removing the</b> .....	<b>15</b>
<b>computer from the bracket mount</b>	
<b>6. Setting tolerances</b>	
<b>7. Installation to the bicycle</b> .....	<b>16</b>
<b>8. Data input</b> .....	<b>17</b>
<b>Trouble Shooting</b> .....	<b>24</b>

## **Warning**

**Be careful not to pay excessive attention to the computer data while riding, otherwise you might have an accident.**

### **NOTE;**

- \* The all clear (AC) button is used to clear the main unit memory.
- \* Never disassemble the main unit, as it cannot be reassembled.
- \* The main unit is fully waterproofed to withstand wet weather conditions; however, do not deliberately place it into water.
- \* Avoid leaving the main unit exposed to extremely hot weather conditions.
- \* Handle the main unit carefully, and avoid subjecting it to any shocks.
- \* Do not use thinner or other solvents to clean parts such as the main unit and sensor, as they may dissolve the part casings.
- \* To clean these parts, wipe them with a cloth soaked in a weak mixture of neutral detergent and water.

# 1. External appearance

## Front

### Main Display

- 1. Current speed (VEL)
- 10. Cadence
- 15. Gear number (digital)

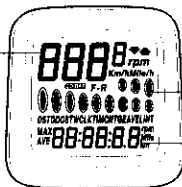

- 17. Gear indicator (bar)

Sub Display  
2-14, 16

## Rear

Switch B

Battery cap

AC All clear Switch

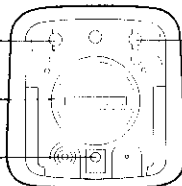

Switch A

Mode button

Start stop button

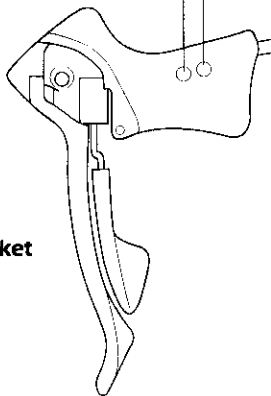

Rear STI Brake Bracket

## 2. Display Contents

mode 1

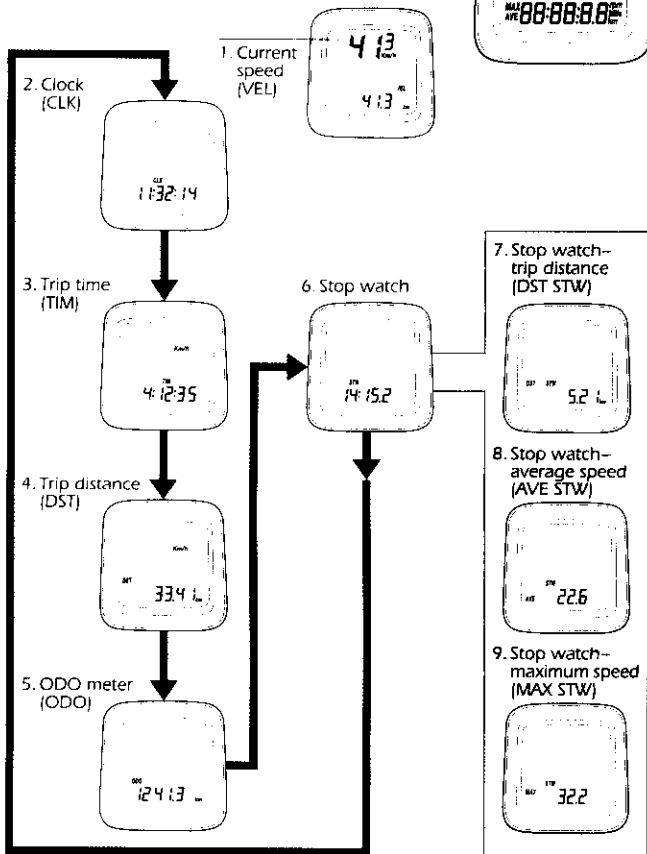

## mode 2



10. Cadence (rpm)

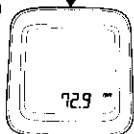

11. Main display cadence



12. Maximum speed



13. Average speed



14. Lap counter



15. Gear number (digital)

16. Gear ratio



17. Gear indicator (bar)

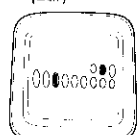

18. Pace Arrow



19. Low battery display

**LO BAT**

# 3. Display Modes

"Current speed" and "Gear indicator (bar)" are always displayed

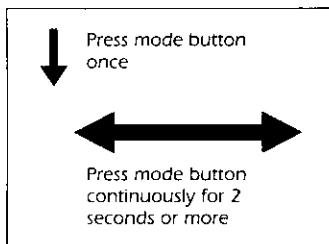
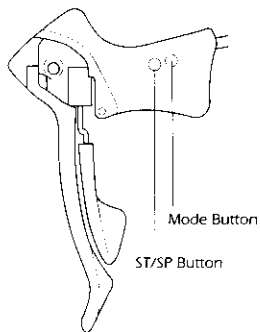
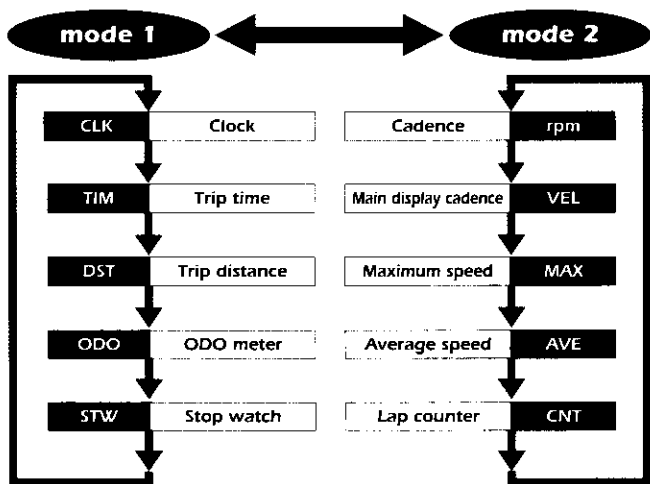

## (1) Current speed (VEL)

0.0 - 130.0 km/h



When main display cadence appears on top

Current speed will appear in the sub - display

0.0 (2.0) - 130.0km/h  
0.0 (1.2) - 80.0mph (Range)  
The current speed will appear at the top of the main display.

## (2) Gear indicator (bar)

0.0 - 130.0 km/h

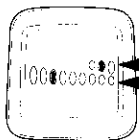

Front display

**Displays;** Low position for double front chainwheel  
Mid position for triple front chainwheel

Rear display

**Displays;** Top for smallest sprocket  
Low for largest sprocket

Gear indicator bar will not appear if the sensor wire is not connected or it has been turned off.

## (3) Time display (CLK)

24-hours clock



Clock will appear when changing mode 2 to mode 1 and during power saver function.

#### (4) Trip distance group (TIM, DST, MAX, AVE)

The trip distance group includes trip time (TIM), trip distance (DST), maximum speed during trip (MAX), average speed during trip (AVE). To activate the trip distance group, press Mode button to (TIM) and press ST/SP button to activate.

The km/mile symbol will blink. The computer will automatically record data whenever the wheel sensor is activated by wheel rotation. The computer will automatically stop recording data when the wheel stops rotating.

To manually stop functions, press the ST/SP button once.

To reset trip distance group, press the Mode button and ST/SP button simultaneously.

Whole group will reset to zero.

Additionally, while this group is operating the km/mph, rpm and F-R displays will flash.

##### **Trip time (TIM)**

0-99:59:59 (h; min; sec)



##### **Trip distance (DST)**

0-999.99 (km, mile)



##### **Maximum speed (MAX)**

0.0 (2.0)-130.0km/h



##### **Average speed (AVE)**

0.0 (2.0)-130.0km/h

0.0 (1.2)-80mph.



##### **Note:**

To calculate the average speed, You must travel for more than 10 seconds or more.

An arrow-up displayed indicates that your current speed is faster than your average speed and an arrow-down if the speed is lower.

If the trip time exceeds 100hours or the trip distance exceeds 1,000kilometers (620miles), "ER" will be displayed and the pace arrow comparison will disappear. However, TIM and DST measurements will start again from zero and the MAX speed will be retained.

## (5) ODO meter (ODO)



## (6) Stopwatch (STW) group

STW  
DST, STW  
AVE, STW  
MAX, STW

This group includes stopwatch trip distance average speed and maximum speed.

The stopwatch is activated by pressing ST/SP button. While the stopwatch group is operating the stopwatch (STW) display will flash.

Stopwatch trip distance (DST,STW) records total during STW function.

Stopwatch average speed (AVE,STW) records the average speed during STW function.

Maximum speed (MAX,STW) records the Maximum speed during the stopwatch function.

Stopwatch (STW)

Stopwatch-Trip distance (DST, STW)

Stopwatch-Average speed (AVE, STW)

Stopwatch-Maximum speed (MAX, STW)

Press mode button to change mode

### Note;

The functions of this group are only available when stopwatch is activated.

If the trip distance mode is also activated simultaneously, it is not possible to view at the distance. However the trip distance, average speed and maximum speed will still be recorded during this time.

**Stopwatch (STW)**  
0.0-90:00 (min,sec)



**Stopwatch trip distance (DST,STW)**  
km mile



**Stopwatch average speed (AVE,STW)**  
km/h mile/h



**Stopwatch maximum speed (MAX, STW)**  
km/h mile/h



## (7) Cadence (rpm)



Cadence is calculated from the F-R gear tooth numbers and current speed.

### **Note:**

Cadence always appears during bicycle movement regardless if the crankarms are rotating.

## (8) Main display cadence (VEL)



Cadence (rpm) can also be shown in main display. Current speed will move to sub-display.

Cadence on main display

Current speed on sub-display

## (9) Lap counter (CNT)



This function is used to count laps, etc. (range 0 - 99)

Lap counter is activated by pressing the ST/SP button.

To reset the counter to zero, press mode and ST/SP button simultaneously.

To reset all of the TIM group, STW group and lap counter values to zero, press the Mode button and ST/SP button simultaneously for 2 seconds or more.

This is possible regardless of what is currently appearing on the display.

## (10) Digital gear number F-R

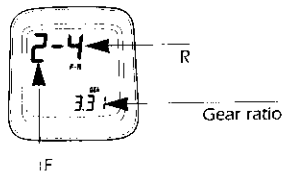

Gear combinations are displayed when a shift has been made. This will only show for approx 4 seconds then original screen will return.

The gear combinations are:

- |                |                |
|----------------|----------------|
| ▪ Front double | ▪ Front triple |
| inner .... 1   | inner .... 1   |
| outer ... 2    | mid ..... 2    |
|                | outer .... 3   |

Rear Numbers are displayed in order starting from low end. Low 1 ..... High ..... 9 etc.

## (11) Gear ratio

Gear ratio is also displayed only when a shift has been made.

This will show for approx 4 seconds.

Gear ratio formula;

$$\text{Gear ratio} = \frac{\text{number of teeth front chain wheel}}{\text{number of teeth rear sprocket}} = \frac{48}{15} = 3.2$$

## (12) Pace Arrow

Moves when distance time is operating



## (13) Low battery display (LO BAT)

This flashes when the remaining battery power is low. The battery should be replaced with a new one as soon as possible.

**LO BAT**

## (14) Power saver function

When the computer is left without receiving any signal or any button activation the unit will be in a "sleep" state and only the clock will appear on the display. The normal display will return as soon as a signal is received or a button has been pressed.

### Note:

During the stopwatch function the stopwatch will continue to operate even when the power saver function has been activated. The stopwatch will stop automatically after 90 minutes have passed.

## 4. Resetting

This function allows you to reset km/h-mph, tire circumference, gear combination, type of rear derailleurs, and time without losing any data (i.e. total distance, trip distance etc)

To re-set go to any display other than CLK on the sub display. Press switch "B" for 5 seconds or more. Then follow instruction section 8 data input.

Switch B 5sec.

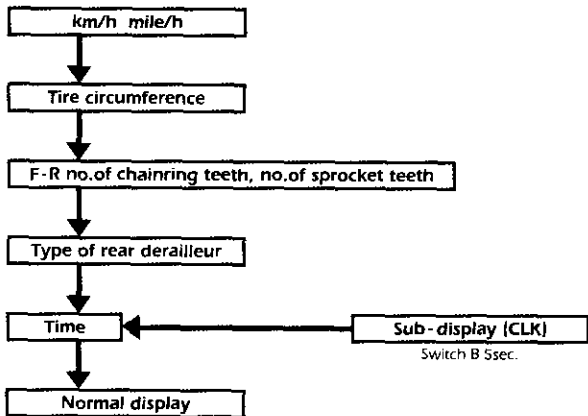

## 5. Viewing data after removing the computer from the bracket mount

The data can still be viewed even when the computer has been removed from the handlebar brakcket.

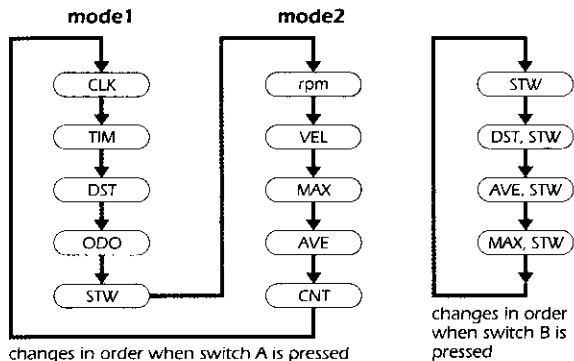

## 6. Setting tolerances

VEL .....	1%
DST, ODO .....	0.05%
CLK .....	30ppm (5minutes or less per month)
STW, TIM .....	50ppm

## 7. Installation to the bicycle

Install the levers to the handlebars. Then connect and adjust the brake shifting cables. Refer to ST - 6501 Service Instructions for details on these procedure.

### (1) Installing the signal cable

Install the signal cable as shown in Figure No1.

Fig.1

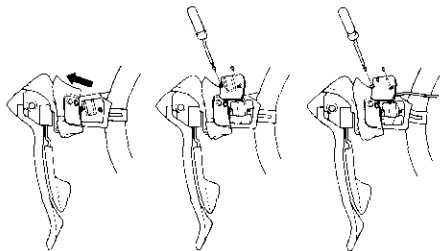

Tightening torque:  
0.3 - 0.5 Nm  
{2 - 4 in. lbs.}

### (2) Installing the computer

Install the band and the bracket as shown in Figure No2.

Tape the signal cable to the handlebars.

### (3) Slide the computer onto the bracket until it clicks into its place.

as shown in Figure No3.

Fig.3

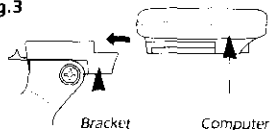
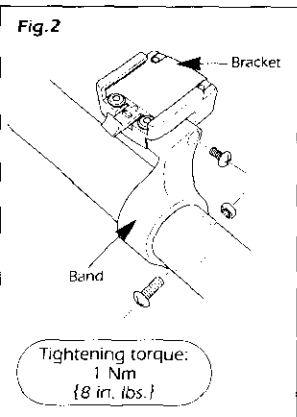

Fig.2



Tightening torque:  
1 Nm  
{8 in. lbs.}

After this, wrap handlebar with finishing tape around the handlebars to secure both the signal cable and the brake cable

#### 4) Installing the magnet and sensors

Use a screwdriver to temporarily secure the magnet to a spoke on the right hand side of the front wheel as shown in fig4.

Put a rubber shim between the fork and the sensor as shown in fig5.

(Fork diameter range is 11-35mm)  
Place the magnet on one of the two sensor lines.

Adjust the position of the magnet so that the distance between the magnet and the sensors is 1-5mm. Secure the magnet and the sensors firmly in these positions. Cut off any surplus band length.

Fig.4

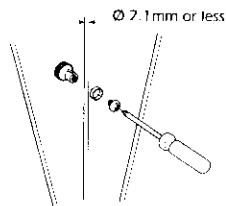
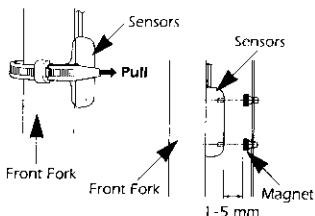

Fig.5



## 8. Data input

- |                           |                            |
|---------------------------|----------------------------|
| 1. Km or Miles            | 4. No. of sprocket teeth   |
| 2. Tire circumference     | 5. Type of rear derailleur |
| 3. No. of chainring teeth | 6. Current time            |

### (1) Measuring the tire circumference

To measure the tire circumference, first ensure that the tire is inflated to the standard tire pressure. Make a mark on the tire and the ground at the point where the tire touches the ground, and move the bicycle forward one full revolution of the front wheel while seated on the bicycle. Mark the point where the marking on the tire touches the ground again. Measure the distance between the two points in millimeters. Round the distance to the nearest multiple of 5mm.

#### Example

2028 - 2032mm	.....	2030mm
2033 - 2037mm	.....	2035mm
2038 - 2042mm	.....	2040mm

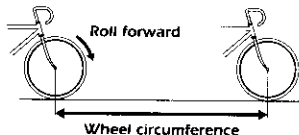

## (2) Checking the number of chainring and sprocket teeth

Check whether the front chainwheel is a double or a triple chainwheel.

### Example

48x38x28 . . . . triple

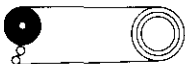

53x39 . . . . . Double

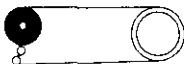

Check whether the cassette has 7, 8, or 9 sprockets.

### Example

12, 13, 14, 15, 16, 17, 19, 21, 23 . . . . . 9 sprocket

12, 13, 14, 15, 16, 17, 19, 21 . . . . . 8 sprocket

## (3) Selecting Km or Miles

When switch "AC" (All Clear) is pressed, the display as shown in fig6 appears and the k/h setting starts flashing. Select your choice for Km/h or Mile/h by pressing switch "A".

Once to look in your choice, press switch "B" continuously for 2 seconds or more to set.

Fig.6

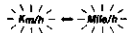

## (4) Entering the tire circumference

The display will appear as shown in fig7, Enter the value which was measured previously.

Fig.7

2050...Tire circumference (mm)

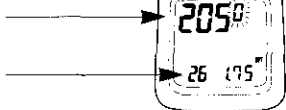

26 1.75 ...Indicates the tire size for 26inch x 1.75

The value will increase by 5mm each time switch "A" is pressed.

The value will change rapidly when switch "A" is pressed continuously.

Once the desired value is displayed, press switch "B" for 2 seconds or more to set.

In the case of tires which have circumference of less than 2050mm, press switch "A" continuously. After the value increased to 2395, it will change to 1700.

Continue pressing switch "A" until the desired value is reached, and then press switch "B" 2 seconds or more to set.

The tire size display can appear as any one of the following 11 displays, in addition to 26 x 1.75 (2050mm)

**Tires with sizes other than these are not displayed**

700 18 .....700 x 18C (2070)

700 19 .....700 x 19C (2090)

700 20 .....700 x 20C (2110)

700 25 .....700 x 25C (2115)

700 28 .....700 x 28C (2135)

26 13/8 .....26inch x 1 3/8(2075)

26 2.00 .....26inch x 2.00 (2085)

26 1 1/2 .....26inch x 1 1/2 (2100)

26 1.00 .....26inch x 1 (1970)

26 1.4 .....26inch x 1.40 (2005)

26 1.5 .....26inch x 1.50 (2050)

### (5) Entering the number of chainring and sprocket teeth

The display will then change to that shown in fig8.

Fig.8

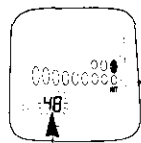

No. of teeth for largest chainring

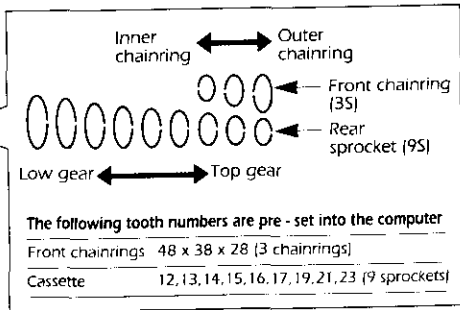

Enter the value starting from the outer chainring. "48" will flash on the display. The value will increase by one tooth each time switch "A" is pressed. The value is set by pressing switch "B". If the value is correct, press switch "B" once to accept the setting.

The "--" is displayed once for every five times the value is changed. If this value is set for the outer chainring by switch "B", all gear indicator related screen display will be eliminated.

When the switch "A" is pressed 2 seconds or more, the value will change rapidly. Once the value reaches 60, the value changes to 40 and then continues increasing to 60 again. After setting the largest chainring the display will change to that shown in fig9.

Fig.9

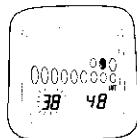

Enter the number of teeth for the inner chainring (for double front chainwheel) or the middle chainring (for triple front chainwheel).

"38" will flash on the display. This position can be set from 20 - 50 by the same procedure of setting outer chainring. After setting the inner chainring or the middle chainring, the display will change to that shown in fig10.

Fig.10

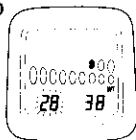

When using a double front chainwheel, press switch "A" once so that "--" is displayed, and then press switch "B" once to set, the front chainwheel will then be registered as a double front chainwheel and the display will change to show the rear sprocket settings.

When using a triple front chainwheel, the value can be set from 15 to 34 by the same procedure of setting middle chainring.

Entering the number of rear sprocket teeth

Fig.11

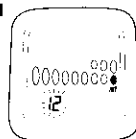

The display will then change to that shown in fig11.

Enter the number of teeth for each sprocket by the same procedure as that used for the chainrings.

Press switch "A" to set the desired number of teeth, and then press switch "B" to accept the setting.

The value can be set from 11 to 42. Once the setting for smallest sprocket through to the 7th sprocket have been made, the display will change to that shown in fig12.

Fig.12

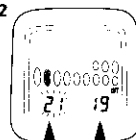

No. of 7th sprocket plus one teeth

No. of 7th sprocket

If the cassette has seven sprockets, press switch "A" once to change the flashing "21" to "--", and then press switch B once. This will indicate that there is no 8th sprockets, and the operation for entering the number of sprocket teeth will be complete.

If the cassette has 8 sprocket, enter the number of teeth for this position and follow the same procedure as above to enter "--" in the 9th position otherwise enter the number of teeth for the 9th sprocket.

### Checking the number of teeth entered

Once the setting of number of sprocket teeth is completed, the display will return to the initial input display. Re check all values by repeatedly pressing switch "B" to

confirm each number of teeth. Press switch "B" once each time and check whether the entered number of teeth are matching with the sprocket position on the display.

If all values entered are correct, press switch "B" for 2 seconds or more to continue the next entry procedure.

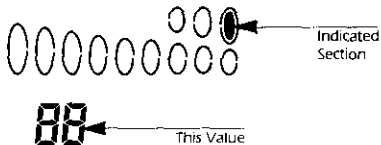

### 6) Entering the type of rear derailleur

The display will change to that shown in fig 13. The display will change from "111" to "222" each time switch "A" is pressed.

111	.....	for Traditional rear derailleur
222	.....	for Rapid Rise Rear derailleur (reverse spring type)

Fig.13



Press switch "B" for 2 seconds or more to continue the next entry procedure.

### (7) Setting the time (24 hour format)

The display will change to that shown in fig 14.

Set the time to one minute later than the current time.

#### Example

If the time is 10:46:23..... 10:47: --

If the time is 13:59:16..... 14:00: --

Fig.14



The hours will advance when switch "A" is pressed. If switch "A" is pressed continuously, the hours will advance rapidly. Press switch "B" once to set the hour.

The minutes section will then start flashing as shown in Fig 15.

Set the minutes in the same procedure as for setting the hours. The clock will then start.

Fig.15



This completes the data entry operations. The display will now return to the normal display mode.

### Note; To reset clock

Got a display where CLK appears on the sub - display. Press switch "B" for 5 seconds or more to change the time setting.

# Trouble Shooting

**\* Speed is not displayed.**

- Check that the positions of the speed sensor and magnet are correct.
- Check that the main unit is fixed correctly to the bracket.

**\* Display does not appear or is faint.**

- Poor contact, or battery is depleted. Replace with a new battery.

**\* Incorrect data is displayed.**

- Press the A/C button to re-enter the data.

**\* Display is dark.**

- This is because the main unit has become hot and has been affected by long-term exposure to direct sunlight, such as can occur during hot weather.
- Store the main unit in a cool, shady place so that it can cool down and return to normal.

**\* Data display movement is slow.**

- The computer operating temperature range is  $-10^{\circ}\text{C}$  to  $50^{\circ}\text{C}$ . Check that the temperature is not lower than  $-10^{\circ}\text{C}$ .

**\* No. of gears and gear ratios are not displayed.**

- Replace the gear number sensor.